

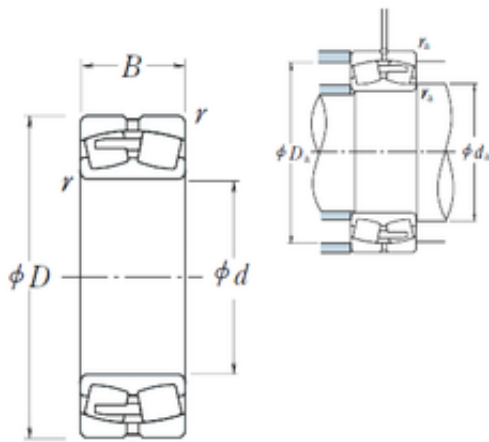

China Lm8uu Bearing Supplier

240/530CAE4 NSK Spherical Roller Bearing



Bearing No. 240/530CAE4

Size	530x780x250 mm
Bore Diameter	530 mm
Outer Diameter	780 mm
Width	250 mm
d	530 mm
D	780 mm
B	250 mm
C	250 mm
r min.	6 mm
da min.	558 mm
Da min	690 mm
Da max.	752 mm
ra max.	5 mm
Weight	390 Kg
Basic dynamic load rating (C)	5400 kN
Basic static load rating (C0)	11800 kN
(Grease) Lubrication Speed	280 r/min
(Oil) Lubrication Speed	360 r/min
Calculation factor (e)	0,31
Calculation factor (Y0)	2,2
Calculation factor (Y2)	3,3

240/530CAE4 Bearing 2D drawings and 3D CAD models