

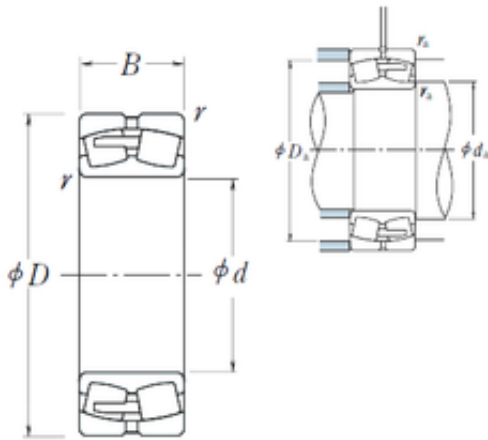

## China Lm8uu Bearing Supplier

### 231/560CAE4 NSK Spherical Roller Bearing



Bearing No. 231/560CAE4

Size	560x920x280 mm
Bore Diameter	560 mm
Outer Diameter	920 mm
Width	280 mm
d	560 mm
D	920 mm
B	280 mm
C	280 mm
r min.	7,5 mm
da min.	596 mm
Da min	804 mm
Da max.	884 mm
ra max.	6 mm
Weight	727 Kg
Basic dynamic load rating (C)	7850 kN
Basic static load rating (C0)	15500 kN
(Grease) Lubrication Speed	240 r/min
(Oil) Lubrication Speed	320 r/min
Calculation factor (e)	0,3
Calculation factor (Y0)	2,2
Calculation factor (Y2)	3,4

231/560CAE4 Bearing 2D drawings and 3D CAD models