

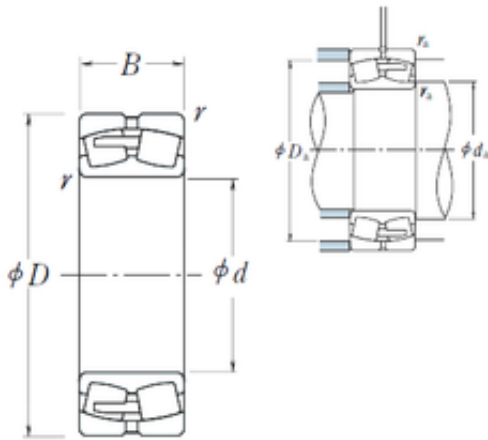

## China Lm8uu Bearing Supplier

### 231/600CAE4 NSK Spherical Roller Bearing



Bearing No. 231/600CAE4

Size	600x980x300 mm
Bore Diameter	600 mm
Outer Diameter	980 mm
Width	300 mm
d	600 mm
D	980 mm
B	300 mm
C	300 mm
r min.	7,5 mm
da min.	636 mm
Da min	856 mm
Da max.	944 mm
ra max.	6 mm
Weight	898 Kg
Basic dynamic load rating (C)	8750 kN
Basic static load rating (C0)	17500 kN
(Grease) Lubrication Speed	220 r/min
(Oil) Lubrication Speed	280 r/min
Calculation factor (e)	0,3
Calculation factor (Y0)	2,2
Calculation factor (Y2)	3,4

231/600CAE4 Bearing 2D drawings and 3D CAD models