

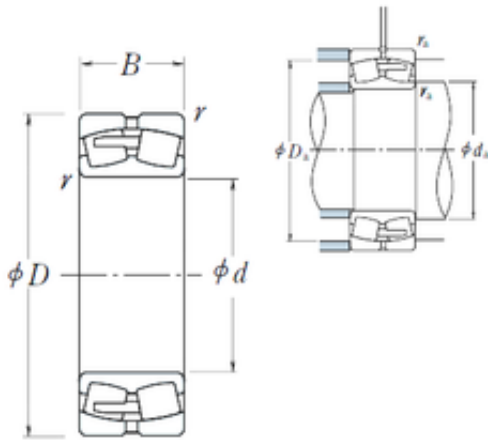

China Lm8uu Bearing Supplier

231/630CAE4 NSK Spherical Roller Bearing



Bearing No. 231/630CAE4

Size	630x1030x315 mm
Bore Diameter	630 mm
Outer Diameter	1030 mm
Width	315 mm
d	630 mm
D	1030 mm
B	315 mm
C	315 mm
r min.	7,5 mm
da min.	666 mm
Da min	900 mm
Da max.	994 mm
ra max.	6 mm
Weight	1040 Kg
Basic dynamic load rating (C)	9600 kN
Basic static load rating (C0)	19400 kN
(Grease) Lubrication Speed	200 r/min
(Oil) Lubrication Speed	260 r/min
Calculation factor (e)	0,3
Calculation factor (Y0)	2,2
Calculation factor (Y2)	3,4

231/630CAE4 Bearing 2D drawings and 3D CAD models