

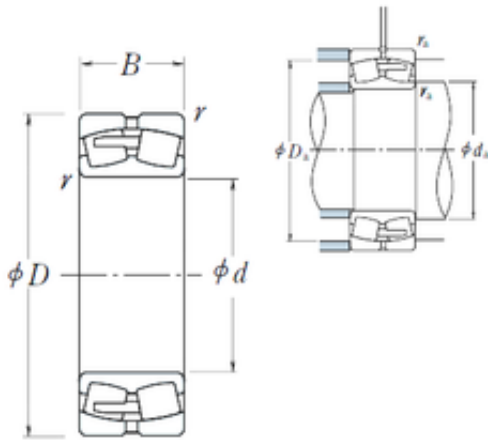

China Lm8uu Bearing Supplier

239/670CAE4 NSK Spherical Roller Bearing



Bearing No. 239/670CAE4

Size	670x900x170 mm
Bore Diameter	670 mm
Outer Diameter	900 mm
Width	170 mm
d	670 mm
D	900 mm
B	170 mm
C	170 mm
r min.	6 mm
da min.	698 mm
Da min	836 mm
Da max.	872 mm
ra max.	5 mm
Weight	300 Kg
Basic dynamic load rating (C)	4350 kN
Basic static load rating (C0)	10300 kN
(Grease) Lubrication Speed	260 r/min
(Oil) Lubrication Speed	340 r/min
Calculation factor (e)	0,17
Calculation factor (Y0)	3,8
Calculation factor (Y2)	5,8

239/670CAE4 Bearing 2D drawings and 3D CAD models