

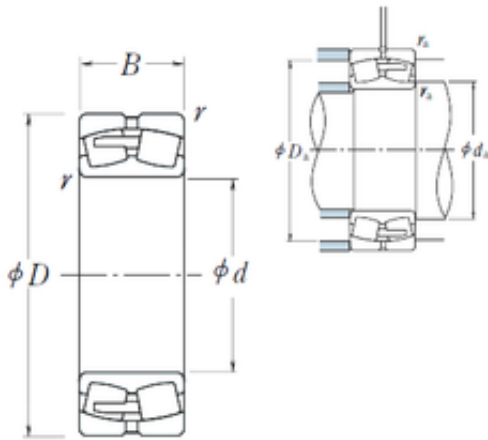

China Lm8uu Bearing Supplier

241/710CAE4 NSK Spherical Roller Bearing



Bearing No. 241/710CAE4

Size	710x1150x438 mm
Bore Diameter	710 mm
Outer Diameter	1150 mm
Width	438 mm
d	710 mm
D	1150 mm
B	438 mm
C	438 mm
r min.	9,5 mm
da min.	754 mm
Da min	981 mm
Da max.	1106 mm
ra max.	8 mm
Weight	1730 Kg
Basic dynamic load rating (C)	13900 kN
Basic static load rating (C0)	30500 kN
(Grease) Lubrication Speed	170 r/min
(Oil) Lubrication Speed	220 r/min
Calculation factor (e)	0,38
Calculation factor (Y0)	1,7
Calculation factor (Y2)	2,6

241/710CAE4 Bearing 2D drawings and 3D CAD models