

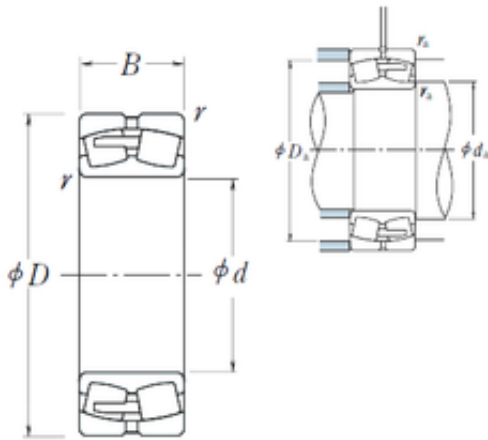

China Lm8uu Bearing Supplier

230/1000CAE4 NSK Spherical Roller Bearing



Bearing No. 230/1000CAE4

Size	1000x1420x308 mm
Bore Diameter	1000 mm
Outer Diameter	1420 mm
Width	308 mm
d	1000 mm
D	1420 mm
B	308 mm
C	308 mm
r min.	7,5 mm
da min.	1036 mm
Da min	1298 mm
Da max.	1384 mm
ra max.	6 mm
Weight	1560 Kg
Basic dynamic load rating (C)	11900 kN
Basic static load rating (C0)	28100 kN
(Grease) Lubrication Speed	140 r/min
(Oil) Lubrication Speed	170 r/min
Calculation factor (e)	0,2
Calculation factor (Y0)	3,2
Calculation factor (Y2)	4,9

230/1000CAE4 Bearing 2D drawings and 3D CAD models